

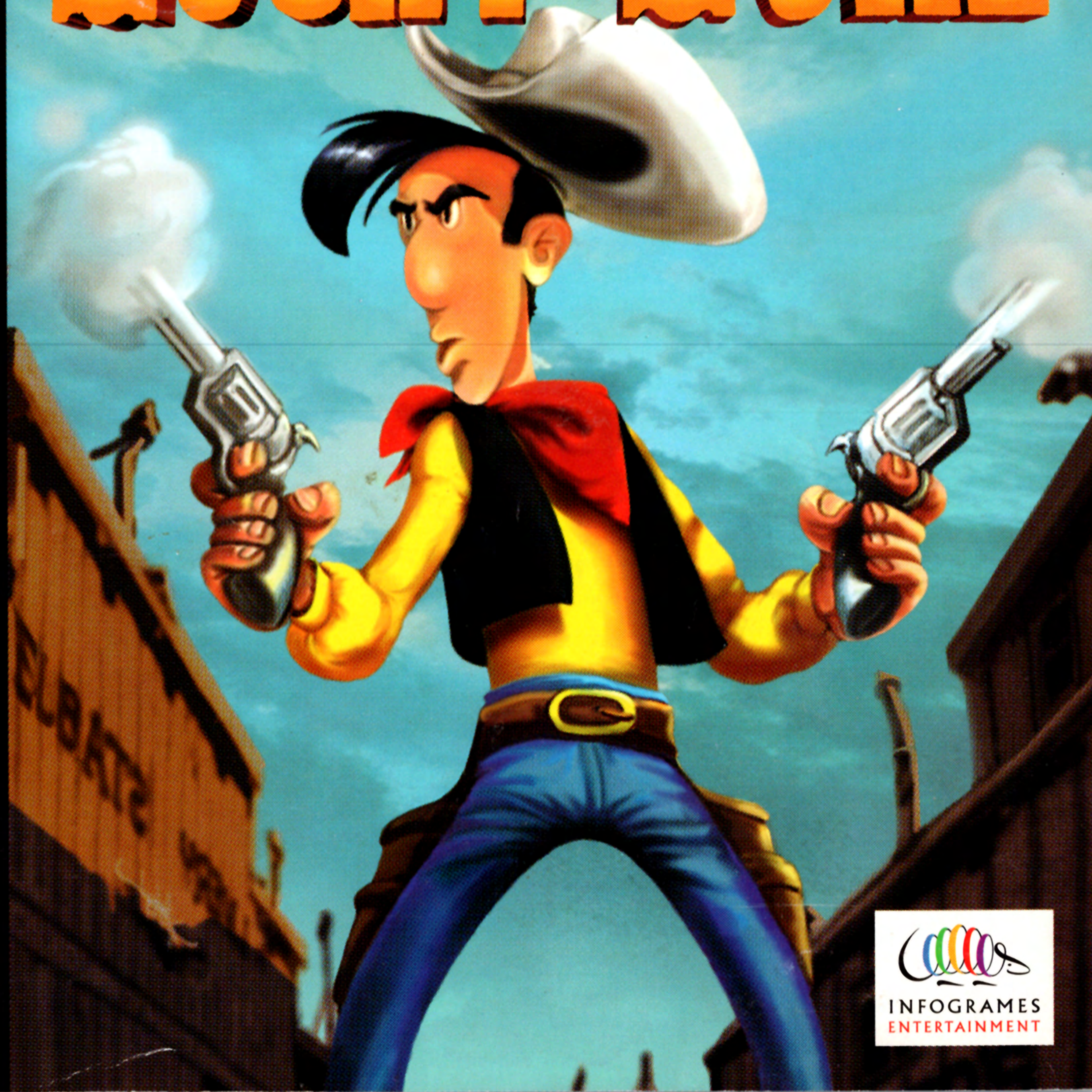

NTSC U/C

PlayStation

LUCKY LUKE



SLUS-00719



LUCKY LUKE

Warning: Read Before Using Your PlayStation® Game Console

A very small percentage of individuals may experience epileptic seizures when exposed to certain light patterns or flashing lights. Exposure to certain patterns or backgrounds on a television screen or while playing video games, including games played on the PlayStation game console, may induce an epileptic seizure in these individuals. Certain conditions may induce previously undetected epileptic symptoms even in persons who have no history of prior seizures or epilepsy. If you or anyone in your family has an epileptic condition, consult your physician prior to playing. If you experience any of the following while playing a video game – dizziness, altered vision, eye or muscle twitches, loss of awareness, disorientation, any involuntary movement, or convulsions – IMMEDIATELY discontinue use and consult your physician before resuming play.

Warning to Owners of Projection Televisions

Do not connect your PlayStation game console to a projection TV without first consulting the user manual for your projection TV, unless it is of the LCD type. Otherwise, it may permanently damage your TV screen.

Handling Your PlayStation® Disc

- This compact disc is intended for use only with the PlayStation® game console.
- Do not bend it, crush it, or submerge it in liquids.
- Do not leave it in direct sunlight or near a radiator or other source of heat.
- Be sure to take an occasional rest break during extended play.
- Keep this compact disc clean. Always hold it by the edges and keep it in its protective case when not in use.
- Clean the disc with a lint-free, soft, dry cloth, wiping in straight lines from the outer edge. Never use solvents or abrasive cleaners.



LUCKY LUKE



CONTENTS

STARTING THE GAME	2
CONTROLLER CONFIGURATION	4
STORY	6
MAIN MENU	6
OPTIONS	7
SCORE BAR	8
BONUSES	9
HOW TO BUY A LIFE OR A PASSWORD	10
POSSIBLE ACTIONS	11
SPECIAL LEVELS	12
BONUS LEVELS	14
HINTS AND TIPS	16
WARRANTY AND SERVICE INFORMATION	21



LUCKY LUKE

STARTING THE GAME

- 1 - Install your PlayStation® game Console according to the instructions given in the Instruction manual.
- 2 - Check that the Console is switched off before you insert or take out a disc.
- 3 - Insert the Lucky Luke Disc, and close the Disc cover.
- 4 - Plug a game Controller into Controller port 1 and switch on the PlayStation® Console.
- 5 - When you have switched your Console on, you'll see the COPYRIGHT screen displayed, then the animated PRESENTATION SEQUENCE, and finally the MAIN MENU.

You are advised not to plug in or unplug peripherals or memory cards while the console is switched on.

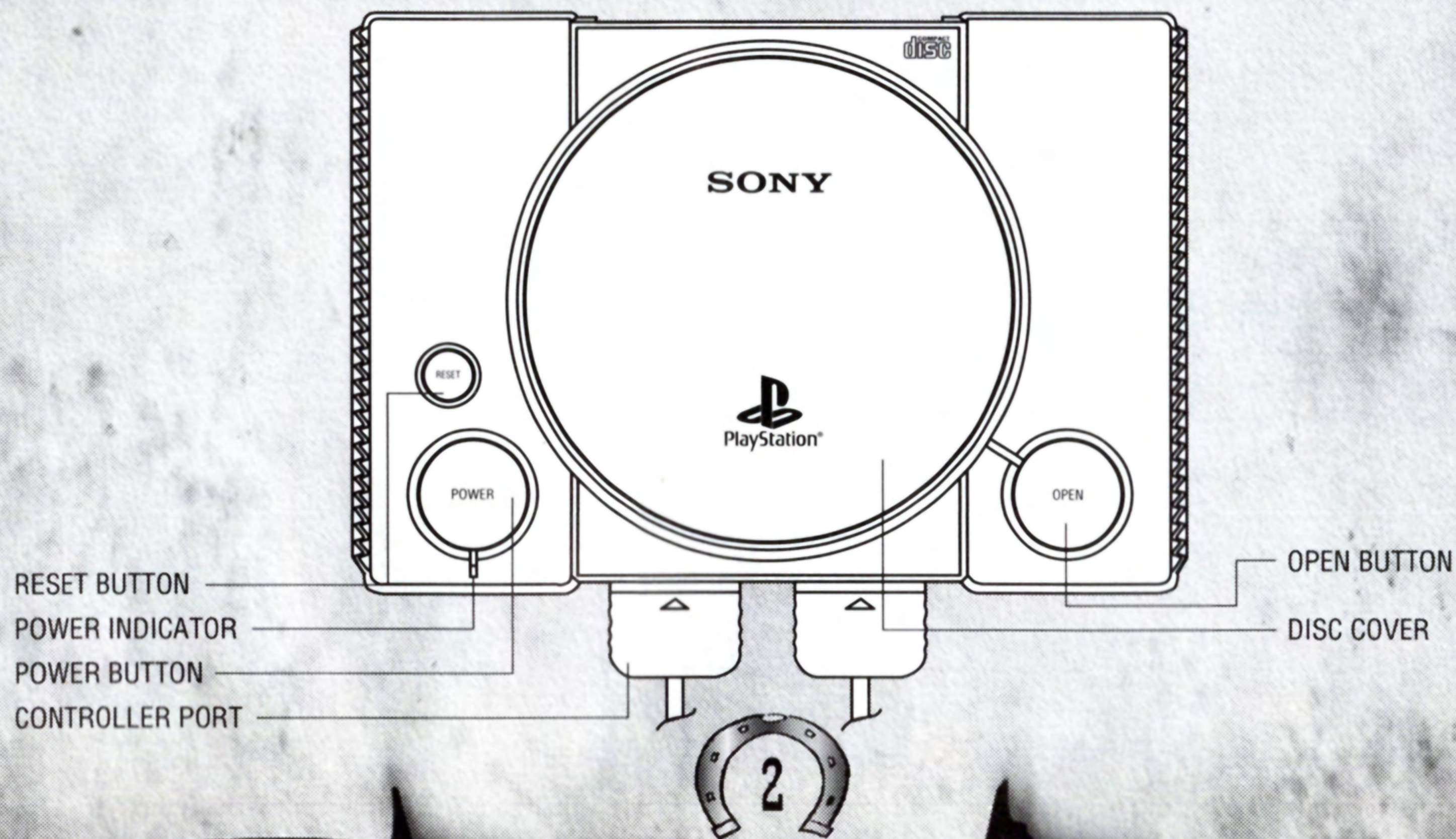

LUCKY LUKE

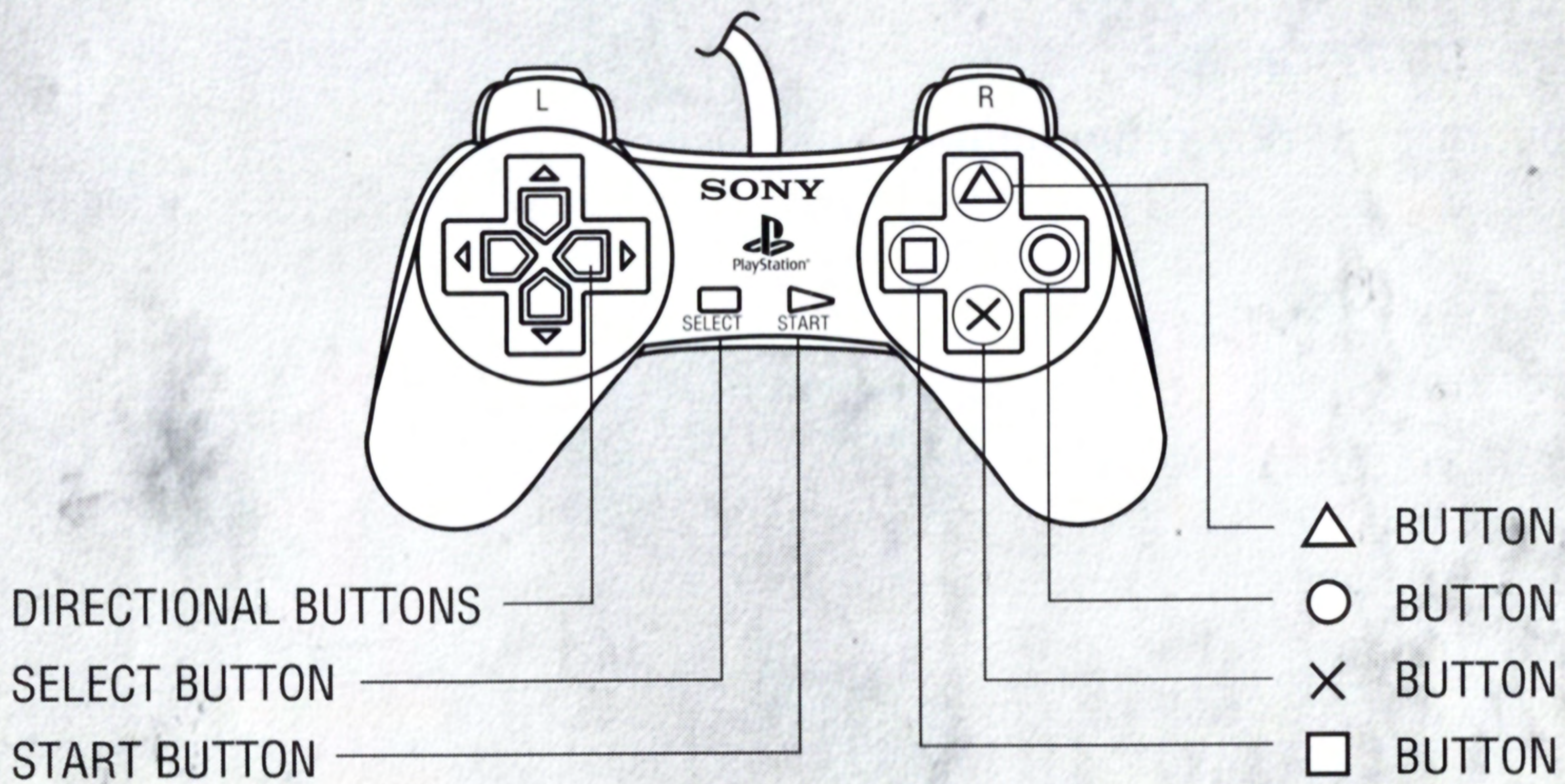
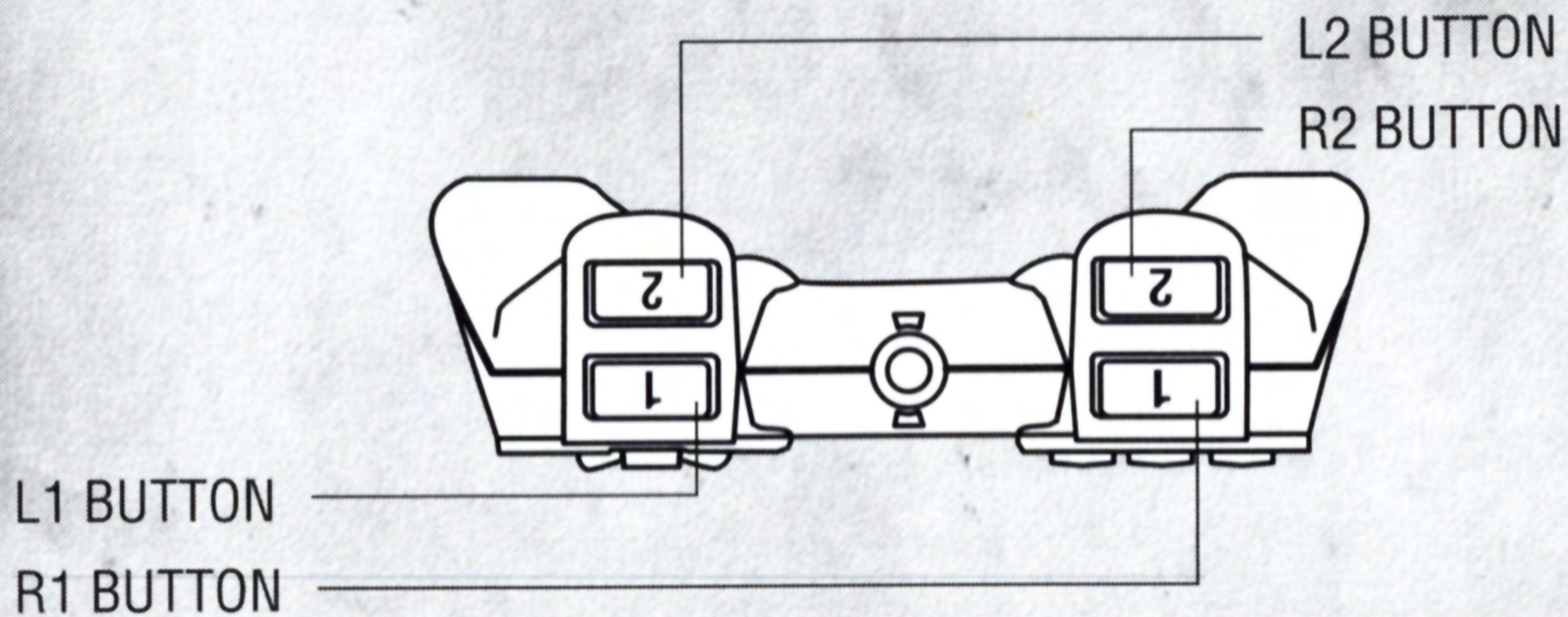

LUCKY LUKE

Highlight the parameter that you want to change, using the up and down Directional buttons, and press the left and right Directional buttons to change the parameter values. When you have made all the changes you want, press the **X** button so that they are all stored in the memory.

• **CONTROLLER CONFIGURATION**

You can select one of three predefined configurations:

CONFIGURATION A

△ button: Put down dynamite

X button: Run

□ button: Jump

○ button: Shoot

L2 button: Show/hide the score bar



LUCKY LUKE

CONFIGURATION B

- △ button: Put down dynamite
- × button: Run
- button: Shoot
- button: Jump
- L2 button: Show/hide the score bar

CONFIGURATION C

- △ button: Put down dynamite
- × button: Jump
- button: Run
- button: Shoot
- L2 button: Show/hide the score bar

• **BACK**

When you are in the options menu and you want to go back to the main menu, position the cursor on the Back sign and press the × button.



LUCKY LUKE

STORY

The life of a Wild West lawman is not exactly restful! Those pesky outlaws, the dreaded Dalton Brothers, have escaped once again from the most heavily-guarded prison in Arizona. Lucky Luke hasn't a minute to lose before setting off to hunt them down. His crazy ride is going to take him all over the Wild West, to the most unexpected places...

MAIN MENU

The main menu appears after the intro-movie. Press the Start button if you want to interrupt this sequence and go immediately to the main menu. On the main menu, you can choose to start the game or to set certain options. Make your selection using the up and down Directional buttons, then confirm it by pressing the **X** button.



LUCKY LUKE

OPTIONS

- **PASSWORD** (saving the game without using a Memory Card)

During your wild ride, you will be able to obtain passwords (made up of four faces arranged in a particular order) that will enable you to play a game without having to start right from the beginning again.

To enter a password (if you have one), select "Password" in the options menu and confirm your choice by pressing the **X** button. Then use the Directional buttons to go to the face that you want to change, and press the **□** button to change the face that is displayed. When the set of faces on the screen is the one you wish to enter, press the **X** button to confirm your selection.

- **SFX**

You can use this sub-menu to:

- select mono or stereo sound
- adjust the volume of the sound effects
- adjust the volume of the music
- listen to any of the game music



LUCKY LUKE

SCORE BAR



Lucky Luke's Face: Lucky Luke's face is shown at the top-left of the game screen, on a panel made of three pieces of wood. Each time Lucky Luke is hit by an enemy or by the explosion of a dynamite charge, one of the pieces disappears. When Lucky Luke has been hit 4 times, you lose a life. The number displayed next to Lucky Luke's face tells you how many lives you have left.

The B (Bonus) Icon: The B icon is shown to the right of Lucky Luke's face. The number displayed to the right of the Bonus icon tells you how many Bonus icons you have picked up in a level.

The Dynamite Charge: The dynamite charge is shown to the right of the Bonus icon. The number displayed to the right of the dynamite tells you how many dynamite charges you have.



LUCKY LUKE

The Dollar Symbol: The dollar symbol is located to the right of the dynamite charge. The number displayed to the right of the symbol tells you how many dollars you have already collected.

The Collected Objects: in certain levels, you must collect objects to solve puzzles. When an object is in your possession, it is shown at the top-right of the screen.

BONUSES

Throughout the game, you can collect the following bonuses:



The Lucky Luke Golden Head: This gives you an extra life.



The Sheriff's Star: This bonus credits your score bar with an extra energy point, unless the energy bar is already at its maximum.

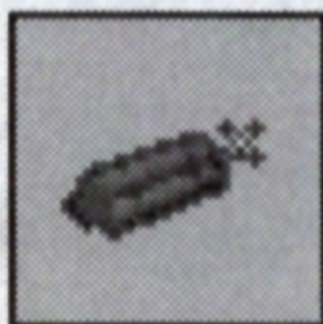

The Dynamite Charge: You can use a charge to blow up obstacles or to get rid of particularly tough enemies.



The Dollars: There are many bonuses spread around all the levels in the form of dollars. Collect as many of them as you can, because you can use them to buy either a life or a password.



LUCKY LUKE

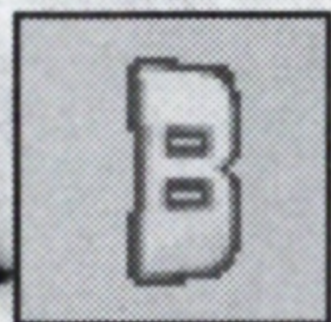

The B (Bonus) icon: 4 Bonus icons are cleverly hidden in each level of the game. If you find all the B icons hidden in a level, you will gain access to one of the three bonus levels of the game, at the end of the level.



Rintincan "checkpoints": Rintincan will appear in some levels. When this happens, if you pass in front of him, your position in the current level will be saved.

HOW TO BUY A LIFE OR A PASSWORD

When you have collected a certain number of dollars, you automatically gain access to the following level "Flatshoe The Hawker's wagon".

You can then choose to buy an extra life (30 dollars) or a password (100 dollars). To make your choice, use the left and right Directional buttons, then confirm by pressing the **X** button.







If you have bought a password, the box to the left opens to show a password made up of four faces. Note it carefully, because you won't be able to see it again once you've left Flatshoe's level.



LUCKY LUKE

POSSIBLE ACTIONS

Here are the actions that Lucky Luke can perform and the corresponding commands. Note that these are the default commands corresponding to configuration A of the Controller.

- **WALK:** use the right and left Directional buttons.
- **RUN:** use the right and left Directional buttons while holding the  button.
- **JUMP:** press the  button to make a small jump. To make a bigger jump, press the  button and the  button at the same time.
- **DUCK / PICK UP AN OBJECT:** use the down Directional button.
- **SHOOT:** press the  button. To choose the direction of the shot, use the Directional button while you are shooting.
- **DETONATE DYNAMITE:** press the  button. Warning: get out of the way fast if you don't want to be blasted!
- **PUSH:** when you can push an object, Lucky Luke automatically takes up the right position. Just use the right or left Directional buttons to move the object.
- **SCORE BAR:** press L2 to display the entire score bar. Press L2 again to hide the score bar.



LUCKY LUKE

- **USE A SWITCH:** use the up Directional button when Lucky Luke is next to the mechanism you want to start.
- **SHOW / HIDE THE SCORE BAR:** use the L2 button.
- **PAUSE ON / OFF:** press the Start button.
- **QUIT THE GAME:** pause the game, then press the Select button. Follow the instructions on the screen.

SPECIAL LEVELS

In some levels of the game, you can perform specific actions.

- **ABILENE BOSS level**

Lucky Luke has changed his weapon... this one is much more useful for bouncing the logs back at his enemy. Here are the special commands:

- To bounce the logs back: press the ○ Button.
- To direct the hit: while pressing the ○ Button, use the right or left Directional Button to hit to the right (forehand) or to the left (backhand). Release the ○ Button to make the hit.

- **SALOON level**

In this level, Lucky Luke has to fight various adversaries with his fists.



LUCKY LUKE

Here are the special actions you can perform:

- JAB: press the **X** button.
- BODY PUNCH: press the **X** button and the down Directional button at the same time.
- UPPERCUT: press the **X** button and the up Directional button at the same time.
- HIGH DODGE: press the up Directional button and the **□** button at the same time.
- LOW DODGE: press the down Directional button and the **□** button at the same time.

• **WAGONS level**

On a wagon rolling at high speed, Lucky Luke can perform the following actions:

- ACCELERATE THE WAGON: press the **X** button.
- TILT THE WAGON TO RIGHT OR LEFT: use the right Directional button or the left Directional button.
- MAKE THE WAGON JUMP: press the **□** button.
- MAKE LUCKY LUKE DUCK: press the down Directional button.



LUCKY LUKE

• *LUMBERJACKS level*

For the first two trials in this level, you must use the following actions:

- INCREASE THE LEVEL OF YOUR FORCE GAUGE: press the ○ button and the □ button alternately. The faster your rhythm, the faster the gauge will move up.
- DISH OUT AN AXE OR CLUB BLOW: when you have reached the maximum energy level for the action, the gauge blinks. Press the △ button to confirm the action.

BONUS LEVELS

• *BOTTLE SHOOTING*

You have to prove that you really are the best shot in the West. Each bottle you hit earns you dollars! What's more, if you hit the watch that Rintincan is holding in his mouth, you'll have more time to shoot the bottles. Careful, don't shoot at everything that moves, because if you hit the bartender your time will be reduced...

• *ARM WRESTLING*

In this trial of strength and endurance, you can gain a life if you beat your opponent. To increase the level of the gauge, press the ○ button and the □ button rapidly one after the other.

When the gauge has reached the maximum level, press the △ button.

LUCKY LUKE

• *THE CARD GAME*

Pat Poker has more than one trick up his sleeve! Now is the time to test your luck...

The rules of the game are simple. 8 cards are laid face-down on the table. Whenever you turn over a card showing Lucky Luke, Jolly Jumper, or Rintincan, you win dollars. But if you turn over the card showing Joe Dalton, you lose all the dollars you have won previously! You can leave this level at any time (by selecting the Exit icon), but remember that the higher the risk you take, the more you might win!

Here are the commands to use when playing with Pat Poker:

- to move the blinking cursor: use the Directional buttons.
- to turn a card over: press the **X** button.



LUCKY LUKE

HINTS AND TIPS

Here are some tips for cowboys in danger...

ABILENE

Find the key to get the dynamite, then blow up the right cases.

ABILENE BOSS

Move to the right place, point to the logs and shoot at them to bounce them back to the boss.

TRAIN 1

Don't save your ammunition: Shoot anything that moves!!!

TRAIN 2

Play ping-pong with the bombs and bounce them back to the boss by shooting at them using careful timing.

PUEBLOS

Find the 10 moon-like pearls hidden in this level. Pearls appear one by one. You have to collect them in the same order they appear. Don't go to visit the sorcerer until you've got all of them... otherwise he'll cast a spell on you.

MINE TUNNELS

Look for the gears which trigger the elevators. Don't forget the keys...

LUCKY LUKE

BUTTERCUT: The counterfeit money printing press

Stop the printing presses and jump at the right moment to get rid of the boss.

INDIAN DESERT

If you want to find the four pieces of the totem pole, then don't be upset by the hallucinations caused by your thirst.

SALOON

Don't use your fists to just hit, use them to defend yourself too!

WATERFALLS

Don't be afraid to do a hamster impression to get the four gold nuggets!

WAGONS

Try switching the points to get out of the labyrinth...

LUMBERJACKS

Flex your fingers before taking on Mc Bride!!!

DALTON CITY

Keep your eyes open and your finger on the trigger if you want to do away with all bandits in the town.

THE BARN

It's all a question of anticipation: Shoot at the hay bales at just the right moment to make the sacks drop over the boss.



LUCKY LUKE

NOTES

Lined area for notes, consisting of 18 horizontal lines.



LUCKY LUKE

NOTES



LUCKY LUKE

NOTES



WARRANTY AND SERVICE INFORMATION

Infogrames Entertainment, Inc. warrants to the original purchaser only that the CD provided with this manual and the software program coded on it will perform in accordance with the description in this manual when used with the specified equipment, for a period of 90 days from the date of purchase.

If this program is found to be defective within 90 days of purchase, it will be replaced. Simply return the CD to Infogrames Entertainment, Inc. or its authorized dealer along with a dated proof of purchase. Replacement of the CD, free of charge to the original purchaser (except for the cost of returning the CD) is the full extent of our liability.

THIS WARRANTY IS IN LIEU OF ALL OTHER WARRANTIES, WHETHER ORAL OR WRITTEN, EXPRESSED OR IMPLIED. ALL IMPLIED WARRANTIES, INCLUDING THOSE OF MERCHANTABILITY AND FITNESS FOR A PARTICULAR PURPOSE, IF APPLICABLE ARE LIMITED IN DURATION TO 90 DAYS FROM THE DATE OF PURCHASE OF THIS PRODUCT.

Infogrames Entertainment, Inc. shall not be liable for incidental and/or consequential damages for the breach of any express or implied warranty including damage to property and, to the extent permitted by the law, damages for personal injury, even if Infogrames, Inc. has been advised of the possibility of such damages. Some states do not allow the exclusion or limitation of any incidental or consequential damages or limitations on how long an implied warranty lasts, so the above limitations or exclusions may not apply to you.

This warranty shall not be applicable to the extent that any provision of this warranty is prohibited by any federal, state or municipal law which cannot be pre-empted. This warranty gives you specific legal rights and you may also have other rights which may vary from state to state.

You may not reproduce, prepare derivative works based upon, distribute copies of, offer for sale, sell, transfer ownership of, rent, lease, or lend to others the Program or accompanying documentation, or any portion or component of the Program or accompanying documentation; provided, however, that you may transfer the entire Program and accompanying documentation on a permanent basis as long as you retain no copies (including archival or backup copies) of the Program, accompanying documentation, or any portion or component of the Program or accompanying documentation, and the recipient agrees to the terms of the Agreement. Further, you may not modify, reverse engineer, disassemble, decompile or translate the Program or accompanying documentation, or any portion or component of the Program or accompanying documentation, nor may you make any copies of the Program modules for use with other programs. This Program is intended for private use only.



INFOGRAMES
ENTERTAINMENT

INFOGRAMES ENTERTAINMENT, INC.

333 W. Santa Clara St., Suite 820, San Jose, CA 95113, (408) 289-1411

www.infogrames.net • www.lucky-luke.com

Infogrames order line: 1-877-INFOGRAMES

Infogrames Tip Line in the U.S. just dial 1-900-78-OCEAN (\$.95 per minute). Must be 18 years or older or have parent's permission to call. Touch-tone only. Prices subject to change without notice.





INFOGRAMES ENTERTAINMENT Inc., 333 W. Santa Clara St., Suite 820, San Jose, CA 95113

© Infogrames Entertainment, Inc. Authorized user. All rights reserved. Licensed by Sony Computer Entertainment America for use with the PlayStation game console. PlayStation and the PlayStation logos are registered trademarks of Sony Computer Entertainment Inc. The ratings icon is a trademark of the Interactive Digital Software Association. Manufactured and printed in the U.S.A. THIS SOFTWARE IS COMPATIBLE WITH PLAYSTATION GAME CONSOLES WITH THE NTSC U/C DESIGNATION. U.S. AND FOREIGN PATENTS PENDING.

